

AGES 8+
71985

LAZER TAG

TEAM OPS™

IRT-2X TAGGER™*

Thank you for purchasing the LAZER TAG IRT-2X TAGGER. Please be sure to read and follow all instructions carefully before using this product.

Requires 6 x 1.5V "AA" or R6 size batteries (not included). Alkaline batteries recommended. Phillips/cross head screwdriver (not included) needed to insert batteries.

NOTE: Not for nighttime play.



TIGER recommends
ENERGIZER® batteries
for ideal performance.

FIND 6 HIDDEN LAZER TAG [CODES]
THROUGHOUT THIS BOOK.

Log-on to lazertag.com and enter your codes to unlock secret bonus game strategies!

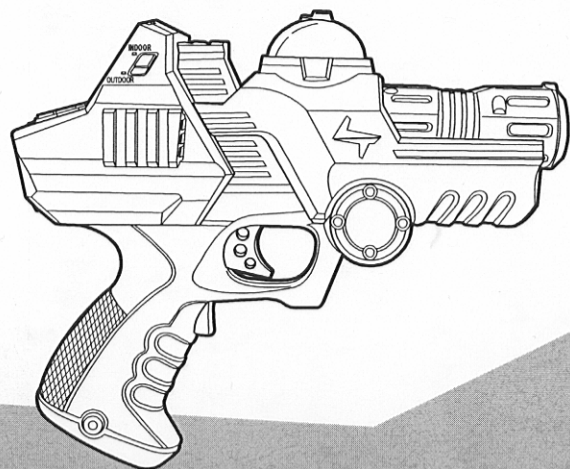

IRT-2X TAGGER is compatible with all LAZER TAG TEAM OPS TAGGER units.

TABLE OF CONTENTS

Quick Start Guide.....	1	Custom LAZER TAG.....	19
Helpful Hints and Introduction.....	2	2 and 3 Team Custom LAZER TAG.....	19
Battery Installation Information.....	3	Hunt the TAG MASTER.....	20
TAGGER Unit Illustration.....	4	Respawn Games.....	21
TAGGER Buttons.....	5	Respawn.....	22
LCD Screen.....	6	2 and 3 Team Respawn.....	22
LAZER TAG Code Of Conduct.....	6	Zone Games.....	22
LAZER TAG Game Features.....	7	Own the Zone.....	23
Programmable Games.....	9	2 and 3 Teams Own the Zone.....	24
How to Host a Game of LAZER TAG.....	10		
How to Join a Game of LAZER TAG.....	12		
To Use Dual IRT-2X TAGGER units in a Game of LAZER TAG.....	14		
Ending the Game in Dual TAGGER Mode.....	16		
End of Game Debriefing and Scoring.....	17		
Ending Games Early.....	18		
11 Pre-Programmed Games.....	18		
Classic LAZER TAG.....	18		

QUICK START GUIDE

For a quick, “Grab & Go” game of LAZER TAG, simply follow these steps:

1. Press the TRIGGER to wake your TAGGER up.
2. Verify that the power-up SFX are played, and “LTAG” appears on the LCD screen.
3. Press the Trigger to start the Classic LAZER TAG “LTAG” game. All players should press their triggers together, so that everybody starts at the same time.
4. The LCD Screen will display a 10-second countdown during which time the players should take their desired positions.
5. At T-0 the TAGGER will say “GOOD LUCK” and the game will begin.
6. Aim and get tagging!

The Classic LAZER TAG game is an “individuals” game, which means that all other players are your opponents. The winner is the last player not tagged out. Each player has unlimited reloads, 15 seconds of shields, and is tagged out after receiving 10 tags from other players.

After a player is tagged out, their Game Timer will continue to run for another four minutes. The tagged-out player may switch between the Game Timer display and the time at which he was tagged-out by using the INC and DEC buttons. Any player who has cheated by restarting their TAGGER in mid-game will have a much lower Game Time than anyone else, so players can check each others' timers to ensure no player has done this.

A TAGGER will go to sleep if there is no activity for four minutes after being tagged out. To maintain your game timer longer than this, press OK once a minute or so until the game is over for all players, then you can compare timers.

Classic LAZER TAG is not a Hosted game, so it does not require Hosting and Joining the way the other more advanced games do. It also does not support Debriefing and Scoring at the end of the game.

To turn your TAGGER off, press 2nd F + CANCEL.

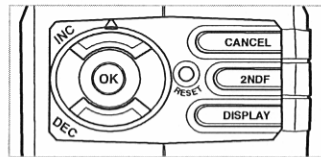

If you'd like to start another game, just press the TRIGGER!

HELPFUL HINTS

1. For Zone Games, set the Indoor/Outdoor Switch to “Outdoor” for a larger zone, or “Indoor” for a smaller zone.
2. During general use, the Indoor/Outdoor Switch should be set at “Outdoor.” If you experience stray or incidental tags when playing in an enclosed area, switch the Indoor/Outdoor switch to “Indoor” to minimize reflective signals.

TAGGER RIGHT SIDE VIEW

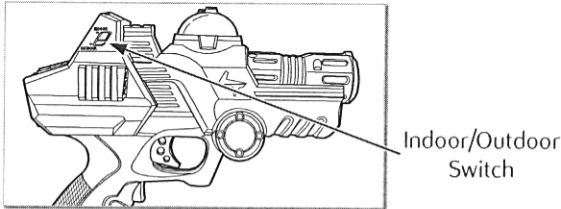

3. There are two sights on the top of the TAGGER Unit to assist in accurate launching of tags. Line up your target by using the two sights for increased accuracy in targeting.

TAGGER LEFT SIDE VIEW

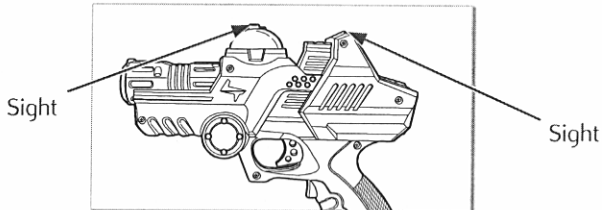

4. Tags can be registered from a distance, even if it exceeds your lock-on and verification capabilities. This means you can sometimes score a long distance tag without audio/visual verification. Even if your TAGGER is not locking on to its target, it is often worth attempting a long distance tag in excess of 100 feet using the manual sight alone.

Thank you for purchasing the LAZER TAG IRT-2X TAGGER™*! Step into LAZER TAG – where video game action comes to life!™* LAZER TAG combines extreme team competition with hi-tech accuracy. Assemble your team and lead them into The Ultimate Game of Electronic Tag™* to become the Tag Master™*!

Please be sure to read and follow all instructions carefully before using this product. Before you can begin playing with your LAZER TAG IRT-2X TAGGER you must first install batteries.

Be the TAG MASTER!

Think you've got what it takes to be the TAG MASTER? Prove it by being the winner in your first game of LAZER TAG! Earn this title and you will have the privileges of being the host for the next game!

TO INSERT BATTERIES

Using a Phillips/cross head screwdriver, loosen the screw in the battery compartment cover of each TAGGER (screw stays attached to cover). Remove cover and battery tray. Insert 6 x 1.5V "AA" or R6 size batteries (not included) into tray. Alkaline batteries recommended. Insert tray, replace cover and tighten screw.

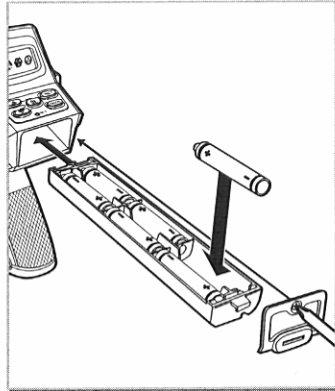

CAUTION: TO AVOID BATTERY LEAKAGE

1. Be sure to insert the batteries correctly and always follow the toy and battery manufacturers' instructions;
2. Do not mix old batteries and new batteries or alkaline, standard (carbon-zinc) or rechargeable (nickel-cadmium) batteries;
3. Always remove weak or dead batteries from the product.

IMPORTANT: BATTERY INFORMATION

Please retain this information for future reference. Batteries should be replaced by an adult.

CAUTION:

1. Always follow the instructions carefully. Use only batteries specified and be sure to insert item correctly by matching the + and - polarity markings.
2. Do not mix old batteries and new batteries or standard (carbon-zinc) with alkaline batteries.
3. Remove exhausted or dead batteries from the product.
4. Remove batteries if product is not to be played with for a long time.
5. Do not short circuit the supply terminals.
6. Should this product cause, or be affected by, local electrical interference, move it away from other electrical equipment. Reset (switching off and back on again or removing and re-inserting batteries) if necessary.
7. RECHARGEABLE BATTERIES: Do not mix these with any other types of batteries. Always remove from the product before recharging. Recharge batteries under adult supervision. **DO NOT RECHARGE OTHER TYPES OF BATTERIES.**

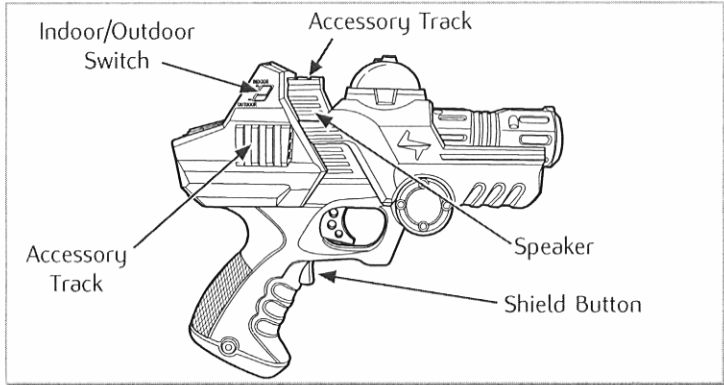

TAGGER RIGHT SIDE

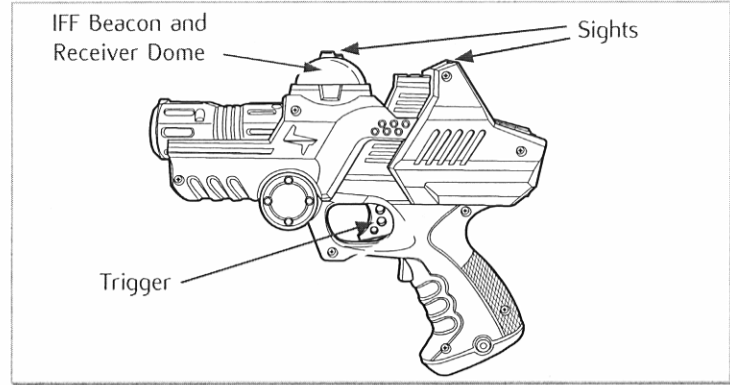

TAGGER LEFT SIDE

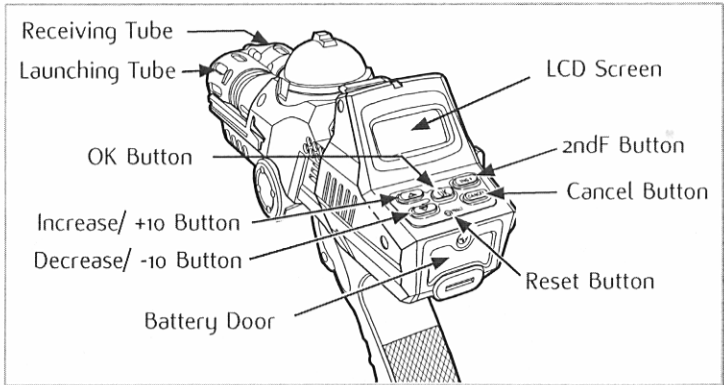

TAGGER REAR VIEW

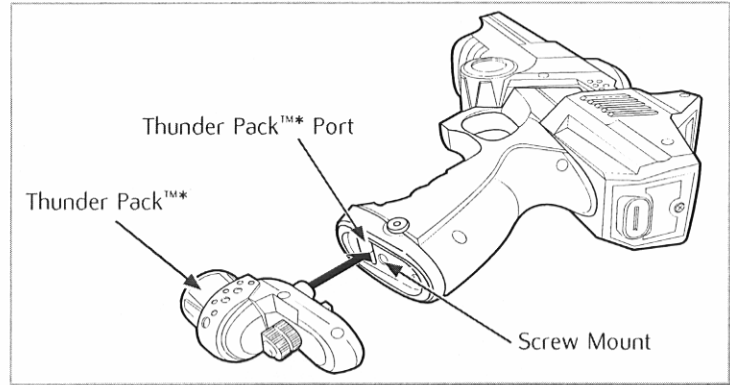

TAGGER WITH THUNDER PACK PORT

BUTTONS

The following buttons are used to enter information into your TAGGER before, during, and after the game. Each button has two functions: its Main Function and its Second Function. In addition, some buttons such as the INC and DEC do different things during the actual game than they do during the set-up, Hosting/Joining, and Post-Game displays.

2nd F

Hold this button down and quickly press then release any of the other buttons to perform that button's Second Function. Pressing and holding 2nd F for more than 2 seconds at any time during an actual game mutes or un-mutes the sound effects.

INC

During the game set-up and post-game displays, this will select the next item in a list of options, or increase a number value by 1. Second Function: 2nd F + INC = Increases the number value by 10. During the games, INC changes the in-game data display while 2nd F + INC increases the LCD contrast.

DEC

During the game set-up and post-game displays, this will select

the previous item in a list of options, or decrease a number value by 1. Second Function: 2nd F + DEC= Decreases the number value by 10. During the games, DEC changes the in-game data display while 2nd F + DEC decreases the LCD contrast.

OK

Enters the selected option or value. Second Function: Starts or ends the game immediately (only the Host can do this).

CANCEL

Cancels the value or option just selected and backs-up a step. Second Function: 2nd F + CANCEL= Quits the game and turns the TAGGER off during game set-up and post-game displays. To cancel a game and turn the TAGGER off in the middle of a game, you must hold the SHIELD button and TRIGGER while holding 2nd F and pressing CANCEL.

INDOOR/OUTDOOR SWITCH

Decreases the intensity of the tag signal for use indoors so that you don't accidentally "splatter" your teammates with reflecting tags.

LCD SCREEN

VISUAL CONFIRMATION SYMBOLS



TAGGED by another player.



LOCKED-ON to another player.



SCORED a hit on another player.



DANGER from a nearby hostile player.

Alpha-Numeric Display (with dual 7-segment numeric display)

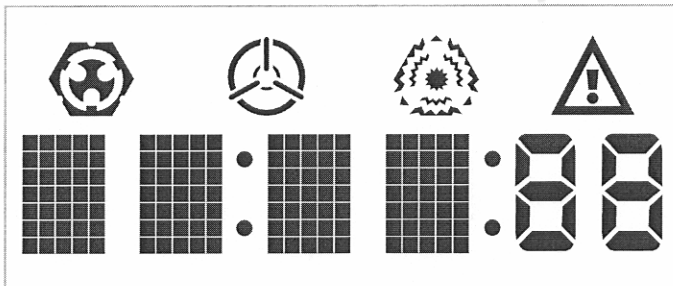

LAZER TAG® CODE OF CONDUCT

LAZER TAG Players follow a strict code of conduct when playing LAZER TAG. The following is the OFFICIAL LAZER TAG CODE OF CONDUCT that should be strictly adhered to in every game of LAZER TAG.

Rule 1: LAZER TAG is a non-contact sport

This means no physical contact between you and other players – EVER!

Rule 2: No covering the Receiver Dome

This means do not use anything to cover up the Receiver Dome thereby preventing you from receiving tags. If you want to avoid being tagged, you must use your defensive shields or take cover behind something.

Rule 3: Equipment Failure means Disqualification

In the event that your TAGGER fails to work, you are disqualified and must wait until the end of the game to join the next one. Please check your TAGGER carefully before entering a game to ensure that it is working properly.

Rule 4: LAZER TAG is a Game

Players must remember that LAZER TAG is only a game. It is designed purely for recreational use and for fun. Not having fun is against the code.

Rule 5: Lazer Tag is a Team Sport

Although LAZER TAG is a highly competitive sport, in many of the games you must consider the success of the team first. Players will win and lose as teams, not individuals. There's no "I" in "TEAM!"

LAZER TAG® GAME FEATURES

Common to all LAZER TAG games are:

- **Lock-On** – Your  on your LCD screen will blink to indicate that there is another player in your sight. Tag your opponent when you are locked-on.
- **IFF** – (Identification, Friend or Foe) You will hear the sounds “bee-bee-beep, bee-bee-beep” if the player you are locked-on to is someone you should be tagging (your enemy), or “poonk-poonk-poonk” if they are someone you should not be tagging (your teammate).
- **Proximity** – You will hear “Danger” if your enemy is nearby.

- **Reloads** – Your IRT-2X TAGGER has an Automatic Reload feature so there is no need to worry about reloading! You cannot launch tags while reloading, but you can raise shields to avoid being tagged.
- **Shields** – You can raise defensive shields, lasting up to 10 seconds each by pressing the SHIELD button once to raise the shield and again to lower the shield. When your shields are raised, your opponents cannot tag you, you cannot launch any tags, and no other player can get a lock-on to you or any IFF info about you. When shields are raised “SHLD” is displayed along with the maximum number of seconds left in the shield. There is a mandatory 2-second cool down period between lowering and raising your shield again, during which the TAGGER displays “SHDS:” and the total number of shields seconds left in the game.
- **Single Tag vs. Burst Tag** – The IRT-2X TAGGER features two distinct ways of launching tags on your opponent. Tap the TRIGGER to launch a Single Tag or hold down the TRIGGER to launch a rapid three tag Burst.
- **T-Minus** – The counter that counts down to start a game.
- **Team Tags** – The Host can choose whether tags from your own teammates will or will not affect you. Make sure you ask whether the TAG MASTER has selected Team tags or not!

Tagging members of your own team counts against your ranking at the end of the game and in some games can hurt your team's ranking as well.

- **Alternate Displays** – You can select which game data you want to have displayed during the game by using the INC and DEC buttons.
 - Game Timer with Tags-Until-Reload: (F = Full = 10 tags left until reloading)
 - TAGS: Number of tags you have left until you're tagged out
 - SHDS: Seconds of shield time you have left
 - RELD: Number of reloads you have left
 - ID: Your Team (if any) and Player Number
 - HIDE or SEEK: What you should be doing in a Hide and Seek game (can only be hosted on Deluxe TAGGER units.)
 - HUNT: Team you are supposed to be hunting in a Hunt the Prey game (can only be hosted on Deluxe TAGGER units.)
 - LT: Player ID of last player to tag you
 - Z: Accumulated Zone Time
- **Pop Up Displays** – During the course of the game, important messages about the game may pop up momentarily on your screen, temporarily overriding your selected display. These are to alert you to such things as becoming neutralized or overheated, or how many tags you have left if you have just taken a tag and are getting near the end of your game.

- **Team and Player Ranking** – At the end of all games except Classic LAZER TAG, the performance of each team and individual player is ranked against all others in the game.
- **Head-To-Head Scoring** – All games except Classic LAZER TAG support head-to-head score comparisons after the Rankings are done. Each player can see how many times he or she tagged another player and was tagged by another player.
- **Mute** – The sound effects may be turned on or off by pressing and holding the 2nd F button for 2 seconds once the game is going – there will be one “beep” to let you know when the key has been recognized, and after that there will be no more sound effects until the game ends or you press and hold 2nd F for another 2 seconds.
- **Contrast/Brightness** – You can adjust the brightness (darkness) of the LCD screen during the game by holding 2nd F and pressing INC or DEC. Remember not to hold 2nd F for too long, or the TAGGER will think you are muting the sound effects.
- **Sleep** – You can quit out of a game during the game hosting/ joining process, during debrief and results, and at any time during an LTAG game, by holding 2nd F and pressing CANCEL.

The TAGGER will go to sleep and the game will be lost. The LCD screen will scroll www.lazertag.com before shutting down.

NOTE: During any Hosted Game, and until the time expires or the game is called off early by the Host, you must hold 2nd F and press CANCEL while holding down the TRIGGER and SHIELD at the same time in order to put your TAGGER to sleep (this prevents accidental shut-off).

PROGRAMMABLE GAMES

Be the TAG MASTER!

Think you've got what it takes to be the TAG MASTER? Prove it by being the winner in your first game of LAZER TAG! Earn this title and you will have the privileges of being the host for the next game!

All of the games except Classic LAZER TAG require the game options to be programmed by the TAG MASTER. Any player can be the TAG MASTER, but there is only one per game. Once the TAG MASTER has programmed all of the game options into his/her TAGGER, it will automatically transfer the options to all of the other TAGGER units as they join the game (these players are called Joiners). The TAG MASTER will have exactly the same

powers and abilities as all of the other Joiner Players in the game, except for in the TAGM game (see page 20) in which the TAG MASTER has the same number of tags and reloads as all of the other players combined.

All programmed games run for a given time (programmed by the TAG MASTER). Once the game ends, all players bring their TAGGER units together with the TAG MASTER TAGGER, which automatically "debriefs" them. The TAG MASTER TAGGER learns how well each player did in the game, and then automatically ranks all players and teams, so that each player can see how well they did as compared to the other teams and players in the game.

In all of the games except for Zone games (RESP, 2TRSP, 3TRSP, OWNZ, 2TOZ, and 3TOZ) the TAG MASTER plays using the TAG MASTER TAGGER. In Zone games, the TAG MASTER must program the game into one TAGGER, which becomes the ZONE TAGGER, and then use his/her own TAGGER to JOIN the game like any other player.

The Zone TAGGER should be set-up so that it is level, not hidden from view, and can easily broadcast its beacon to a large enough area that players may move around in it and still remain "In the Zone."

NOTE: When setting up to Host or Join a game, and during Debriefing, please make sure to hold all TAGGER units level and at similar heights. If possible, all players should stand in a circle each approximately 6 feet from the TAG MASTER while facing the TAG MASTER.

NOTE: Deluxe TAGGER units can play all of the games described in this booklet. IRT-2X TAGGER units can play in all of the games that the Deluxe TAGGER hosts. However, please note that different TAGGER units have different capabilities, so not all special modes are available in all TAGGER units.

TO HOST A GAME OF LAZER TAG®

1. Press the TRIGGER to wake up your TAGGER.
2. The TAGGER will make a power-up sound and then display the Main Menu which has five options:

- LTAG – Play a basic Grab & Go game of Classic LAZER TAG.
- JOIN – Join a game Hosted by another player.
- DUAL – Enter into a Hosted game as a Dual TAGGER.
- HOST – Be the TAG MASTER and host a game for other players to join.
- QUIT – Return to “sleep” mode.

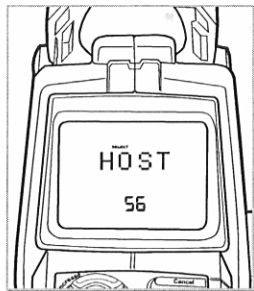

3. Use the INC. and DEC. buttons to scroll to HOST and press OK.

You are now in the Host Menu where you will have the following 11 game options to choose from:

- CUST – customized game for individual players
- 2TMS – customized game for 2 teams
- 3TMS – customized game for 3 teams
- TAGM – Hunt the TAG MASTER game
- RSPN – Respawn game for individual players
- 2TRS – Respawn game for 2 teams
- 3TRS – Respawn game for 3 teams
- OWNZ – Own the Zone game for individual players
- 2TOZ – Own the Zone game for 2 teams
- 3TOZ – Own the Zone game for 3 teams
- LAST – Once a game has been successfully hosted, it is stored here. You may recall and re-host it with all of its custom settings in-place.

“Individual players” means the players are not divided into teams, it’s “every player for them self.” All Hosted games must have at least 2 players.

4. Use the INC and DEC buttons to scroll through these options to the game you want and press OK. Now it’s time to configure the selected game:

- TT: Y or N – Team tags, yes or no. Decide whether tags from players on your team do (Y) or do not (N) count against you.

- MM: Y or N – Medic Mode, Yes or No. Decide whether players on a team can (Y) or cannot (N) assist their teammates by transferring some of their remaining tags to their teammates.
- TIME: <##> - Time limit for the game, in minutes. This can be anywhere from 1 to 99 minutes.
- RELD: <##> - Number of reloads available for each player. Each reload gives you 10 additional tags. This value can be anywhere from 0 to 99, or unlimited (“UL”).
- MEGA: <##> - Number of Mega-Tags available for each player. This value can be anywhere from 0 (no Mega-Tags allowed) to 99, or unlimited (“UL”), but can never be greater than the total number of tags.
- SHLD: <##> - Total seconds of shield time available for each player. This value can be anywhere from 0 (no shield time allowed) to 99 seconds.
- TAGS: <##> - Number of Tags each player can take until they are tagged out. This can be any number from 1 to 99.

NOTE: IRT-2X TAGGER units cannot generate Mega-Tags and cannot request nor assist in Medic Mode transfers. These options allow the Host to define whether or not other types of TAGGER units, such as the Deluxe TAGGER, will be allowed to use these special modes of theirs during the game.

5. Program the functions for the game using the INC and DEC buttons to increase or decrease the value or to switch between Y and N. You may also hold down the 2nd F button

and press INC or DEC to increase or decrease the value by 10. If you want to select “UL”, it is located just below 00 or just above 99. Once you have adjusted each value to your desired amount, press OK to select that value and move on to the next option to be adjusted.

If you need to go back and change something, you can press CANCEL to back-up through the options until you get to the one that you want to change. All the other options that you have already set will remain programmed, so you can simply press OK to keep the programmed value.

Once you have set the number of TAGS (the last option), the screen will display: “IN:” with a number, and will begin making a sound effect. This sound effect indicates that the TAG MASTER will start joining other players into the game. The number is the total number of players who are now in the game including the TAG MASTER if it is not going to be Zone or Respawn.

The TAG MASTER needs to wait until all players have successfully joined the game before starting the game. Once at least 2 players are in the game, the T-Minus countdown will begin automatically if additional players do not successfully join the game for a 60-second period. The TAG MASTER can delay the automatic start of the T-Minus

countdown by pressing OK at any time to restart the 60-second timer. Alternatively, the TAG MASTER can start the game immediately at any time after at least 2 players are in the game by pressing 2nd F and OK.

- The T-Minus countdown runs for 30 seconds before the start of the game and is used to allow all TAGGER units in the game to synchronize their Game Timers. The TAG MASTER's LCD screen will count down from T-30, T-29, T-28 etc. (for individual games) and T1: T-30, T1: T-29, T1: T-28 etc. (for team games) and beep each time to alert the players, until it reaches T-00 at which point the TAGGER will say "GOOD LUCK!" and the game begins! All Joiner players must remain close to the TAG MASTER during this countdown until their screens also begin displaying the T-Minus countdown. The TAG MASTER should remain in one place until all other players have begun the T-Minus countdowns on their own screens, at which time the TAG MASTER is free to take up his/her initial position.

NOTE: If you are Hosting a Zone game (OWNZ, 2TOZ, 3TOZ) the TAG MASTER TAGGER will become the Zone, not a player TAGGER. When the T-Minus countdown screen has concluded and the TAGGER says "GOOD LUCK!" it will display "Z" on the LCD screen and the number of minutes and seconds remaining in the game. Similarly, if you are Hosting a game of

Respawn (RESP, 2TRS, or 3TRS) the TAG MASTER TAGGER will become the Respawn Zone and will display "R" on the LCD screen along with the number of minutes and seconds left in the game.

NOTE: Once the TAG MASTER TAGGER begins the Joining process, the game is set and cannot be modified. To terminate the game before it has begun, all players must hold their 2nd F buttons and press CANCEL to put their TAGGER units to sleep.

TO JOIN A GAME OF LAZER TAG®:

NOTE: In order to join a game, the Joiner TAGGER must remain physically close to the TAG MASTER (within 10 feet) until your TAGGER starts the T-Minus countdown.

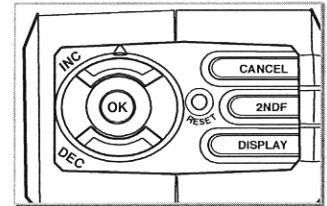

NOTE: It may take some time for each Joiner to enter the game, as the TAG MASTER registers players one at a time. Please join games one at a time otherwise the TAG MASTER TAGGER may get overloaded with information and it will take longer to begin a game.

1. Press the TRIGGER to wake up your TAGGER.

2. The TAGGER will make a power-up sound and then display the Main Menu which has five options:
 - LTAG – Play a basic Grab & Go game of Classic LAZER TAG.
 - JOIN – Join a game Hosted by another player.
 - DUAL – Enter into a Hosted game as a Dual TAGGER.
 - HOST – Be the TAG MASTER and host a game for other players to join.
 - QUIT – Return to “sleep” mode.
3. Use the INC and DEC buttons to scroll to “JOIN” and press OK. The LCD screen will display “WAIT” as it waits for instructions from the TAG MASTER, and will display a countdown to show how many seconds are left to join the game. If you were not able to join the game in the allotted time, your TAGGER declares a failure to join the game by playing a sound effect and displaying “NO GAME” in the Text Read-Out.
4. Upon communication with the TAG MASTER, the joining TAGGER will receive the game set-up information. For individual games the TAG MASTER will control all game set up and game start automatically. Skip to Step 6 for individual games.
5. For games with teams, your LCD screen will display “TEAM: -” prompting you to select a team. Select your desired Team by pressing the INC and DEC buttons and then OK. If you do not

care which team you join, select “-” then press the OK button and the TAG MASTER will assign you to the team with the fewest players, in order to keep the teams even.

NOTE: The team you are assigned to may be different from the team you requested. The TAG MASTER TAGGER will attempt to honor all team requests, but it cannot assign more than 8 players to any given team. Players should discuss who will be on which team, before the game is set up by the TAG MASTER. In the TAGM game, all Joiner players will be assigned to Team 2 regardless of which team they chose.

6. When the Joiner enters the game the LCD screen will display “IN!” for 2 seconds, then show your Team and Player number. Use this information to determine who your teammates are.
7. It is VERY IMPORTANT that you remain near the TAG MASTER TAGGER. If you wander away from the TAG MASTER TAGGER, your TAGGER will prompt you to “FIND HOST”. If you do not return to the vicinity of the TAG MASTER within 60 seconds, you will be dropped from the game and your LCD screen will show “FAIL”. You must then either re-join the game (receiving a new Team and Player ID) or sit out this game.
8. Once all players have joined the game, the TAG MASTER TAGGER will enter the T-Minus countdown screen. The TAG

MASTER's LCD screen will count down from T-30, T-29, T-28 etc. (for individual games) and T1: T-30, T1: T-29, T1: T-28 etc. (for team games) and beep each time to alert the players, until it reaches T-00 at which point the TAGGER will say "GOOD LUCK!" and the game begins! It is VERY IMPORTANT that you remain near the TAG MASTER TAGGER until your own LCD screen begins displaying the T-Minus countdown. Once your screen starts the T-Minus countdown, you can safely go to your starting position and/or program your secondary TAGGER if you are using Dual TAGGER Mode. When the T-minus countdown reaches "T-00" the game will start automatically, and will run for the selected number of minutes.

TO USE DUAL IRT-2X TAGGER UNITS IN A GAME OF LAZER TAG:

In Dual TAGGER mode you get to use two IRT-2X TAGGER units at the same time! This allows you to engage two opponents in different directions at once and still get the correct score and rankings!

Select one IRT-2X TAGGER to be your primary TAGGER and Join or Host the game with it as you normally would. Then select another IRT-2X TAGGER to use as your secondary TAGGER. This

secondary TAGGER enters the game in a special way, so that it does not take up a Player ID for itself but instead uses the same ID as the primary TAGGER:

1. Press the TRIGGER to wake-up the secondary TAGGER, and verify that it generates a sound effect and displays "LTAG" on the LCD screen.
2. Use the INC and DEC buttons to scroll to DUAL, then press OK.
3. Your secondary TAGGER will now display "WAIT" and a countdown while it listens for the game definition from the TAG MASTER TAGGER. Once this information is received, your secondary TAGGER will display the name of the game being hosted ("RSPN" for example). If your secondary TAGGER does not hear the game definition within 60 seconds, the secondary TAGGER will display "NO GAME" and will cancel the process.

After receiving the game definition, if you wander away from the TAG MASTER TAGGER your secondary TAGGER will begin making an alert sound and display "FIND HOST". If you remain away from the TAG MASTER TAGGER for more than 60 seconds, your secondary TAGGER will display "FAIL" and will cancel the process.

Once the T-Minus countdown begins and is received by your secondary TAGGER, your LCD will display "PRG -" and the

T-Minus countdown time. This indicates that it is time for the DUAL TAGGER to be programmed with the primary TAGGER unit's Player ID. To do this:

1. Turn your back to the Host and walk approximately 10 feet away from all other players.
2. Point both IRT-2X TAGGER units down at a light-colored spot just in front of your feet, or on a wall approximately 2 feet away.
3. Press the TRIGGER on the primary TAGGER.

The primary TAGGER will make a “woo-woo-whoop” sound effect to indicate that it is synchronizing with the Dual TAGGER. You will then hear the Dual TAGGER make a “ta-dah” sound effect, and both IRT-2X TAGGER units will display the T-Minus countdown, to indicate that the synchronization has been completed successfully.

If you hear an error sound, like a buzz, and your secondary TAGGER unit's screen is displaying “???” with a countdown, it means your secondary IRT-2X TAGGER became confused and your two TAGGER units are not synchronized. To redo the synchronization process do the following:

1. Continue to point both IRT-2X TAGGER units down at the spot just in front of your feet, or at the same spot on a wall approximately 2 feet away. The secondary TAGGER will soon display either the T-Minus countdown (if it is able to synchronize

by itself) or else return to the “PRG-” display if it fails to synchronize. In this case:

- a. Press the TRIGGER on the primary TAGGER again.
- b. Repeat every 2-3 seconds until successful.

NOTE: If the TAG MASTER TAGGER is to be used in Dual TAGGER Mode during a game, you must wait until the T-Minus countdown reaches T-20 or less before you can program your secondary TAGGER. This is to allow all of the other players time to receive the T-Minus countdown from the TAG MASTER TAGGER before it has to divert its attention to programming a secondary TAGGER.

NOTE: The “Tx:” Player ID does NOT appear on the secondary TAGGER in Dual TAGGER Mode until synchronization/programming has been completed successfully.

Once you have successfully programmed your secondary TAGGER, you will begin the game in Dual TAGGER Mode! Each of your IRT-2X TAGGER units has half the number of reloads and half the number of tags it can take until being out of the game, but you can engage twice as many opponents at the same time!

In addition, you can continue to launch tags from one while the other is reloading, and if you practice launching alternating bursts of tags from the two TAGGER units you will be able to keep up a constant barrage of tags without ever overheating. Each of your IRT-2X TAGGER units will have the same game time

and shields as any other player in the game. But be careful – a well-placed tag from one of your opponents just might hit BOTH of your TAGGER units, counting as TWO hits against you!

NOTE: If your secondary TAGGER becomes confused during programming and every attempt to synchronize fails, or if you change your mind and never attempt to program it with the primary TAGGER ID, the LCD screen on the secondary TAGGER will display “NO GAME” and will go to Sleep. However, the primary TAGGER will be able to play in the game and will have a full set of capabilities for the game, just as if you had not been using Dual TAGGER Mode.

NOTE: You cannot use Dual TAGGER Mode if you are a KING in a 2KNG or 3KNG game (hosted on a Deluxe TAGGER) or if you are the TAG MASTER in a TAGM game. This is to prevent cheating by hiding one or the other of the two TAGGER units so that you could never be tagged-out, which is the basis of the scoring for these types of games.

ENDING THE GAME IN DUAL TAGGER MODE:

Once the game has ended, the data from your two IRT-2X TAGGER units must be combined before reporting back to the Host. This process, called “un-DUALing” is automatic but may

require you to take steps to ensure it can happen without interference from other nearby TAGGER units.

The primary TAGGER will display “UNDL” and the Dual TAGGER will display “WAIT.” Step away from all other TAGGER units, turn your back to them, and hold both IRT-2X TAGGER units side-by-side in front of you. After a few seconds, the Dual TAGGER will go to Sleep and the primary TAGGER will display “FIND HOST”. At this point, continue to follow the debrief process as usual.

NOTE: If any player enters the game in Dual TAGGER Mode, but does not un-DUAL properly within 30 seconds after the end of a game, he/she will be treated as though they abandoned the game. In this case, the player will not receive a personal score and their “abandoning” of the game may count against their team – so be sure that you un-DUAL properly at the end of each game!

If the Host used the Dual TAGGER Mode themselves, the Host must first un-DUAL themselves and then debrief all the other players.

If the game is to be ended early by the Host pressing 2nd F + OK, the TAG MASTER TAGGER must first un-DUAL if needed. Once this is done, all other players need to come within the vicinity of the TAG MASTER TAGGER one at a time and receive the command to end their games early. Once each player’s

TAGGER units have ended their game (their primary TAGGER will display “UNDL” and their secondary TAGGER will display “WAIT”), that player must then leave the area of the Host temporarily so that the un-DUALing process can occur without interference, as described above. Once that has happened, the primary TAGGER will display “FIND HOST” and the Dual TAGGER will scroll www.lazertag.com and then go to sleep. The player now brings the primary TAGGER back to the TAG MASTER TAGGER and is debriefed in the normal manner.

END OF GAME DEBRIEFING AND SCORING

The game ends and the debriefing process begins when the game timer runs out. If you are tagged out before the game ends, your TAGGER will continuously display “WAIT FOR GAME OVER” alternating with the time left until the game ends.

When the game ends, your TAGGER will display “GAME OVER” and then constantly prompt you to “FIND HOST.” You now have 2 minutes to return your TAGGER to the TAG MASTER in order to be debriefed. You must then remain within 10 feet of the TAG MASTER until the Debriefing process is complete in order to receive your ranking. Because of the 2-minute time limit for returning to the TAG MASTER, all players should reach an agreement before the game starts about where they will meet

for the debriefing, so that there is no confusion. If you cannot make it back to the TAG MASTER TAGGER within the 2 minute time, press the TRIGGER on your TAGGER approximately every 30 seconds as you return so that your TAGGER will not give up and declare a debrief failure.

During the debriefing process, the TAG MASTER’s screen will prompt the TAG MASTER to find each of the other players in turn by displaying “?” with the ID of the desired player while waiting approximately 3 seconds to contact that unit. If the Player’s TAGGER is present, the TAG MASTER will automatically download all of the score information and will use it to calculate how he/she and their team did in the game. If a player is slow in getting to the debriefing, the TAG MASTER can temporarily skip over him/her by pressing OK to move on to the next Player’s TAGGER to be debriefed. This also restarts the 2-minute timer, allowing more time for distant players to return and be debriefed. The TAG MASTER will eventually come back to the skipped TAGGER automatically and debrief it. If a player has quit the game, reset their TAGGER or put their TAGGER to sleep (so that their data cannot be gathered), the TAG MASTER can press CANCEL to drop that player from the game. This should only be done as a last resort, because all tags which that player landed on the other players will count against the other players, but

those same other players will not get credit for any tags they landed on the missing player. In addition, the loss of that player may count against the player's team.

When the debriefing is complete, the TAG MASTER will upload the rankings for each player and team to all the TAGGER units automatically. All player LCD screens will display three or four different options (press INC and DEC to switch between them):

- PRNK and TRNK – How you and your team ranked in the game
- ID – What your player and team numbers are
- VS – View a head-to-head comparison of how you did versus each of the other players in the game. To enter this display mode, press OK then use the INC and DEC buttons to select which opposing player you want to see data for. Each other player in the game is shown as "TxPy" (Team X, Player Y on that team), or just "P: xx" (Player XX) if there were no teams. Press OK to request this data from the other player's TAGGER and display it in a scrolling message on your screen – if your TAGGER cannot get the data from the other TAGGER in time, it will display "??" instead of a number for how many times you tagged them – you can request the information again later when the other player's TAGGER is closer by or not so busy. If you need to get out of the "VS:" display, you may press CANCEL and you will be back in the Player ID screen.

ENDING GAMES EARLY

All Hosted games will normally end at the programmed time limit. However, the TAG MASTER can declare an early end to the game by holding 2nd F and pressing OK. The TAG MASTER will then immediately end his/her own game, proceed to un-DUAL if needed, and then begin debriefing any players nearby. All players must be called to come to the TAG MASTER within 2 minutes, or the TAG MASTER will count them out of the game and they will receive no score – so make sure everybody knows that you are calling an early end to the game.

Any player who was not yet tagged out at the time the game was called early will be considered to have not been tagged out in the game.

NOTE: It is recommended that OWNZ, 2TOZ, and 3TOZ games should not be ended early. If a Zone game is ended early, zone times for players who were not tagged-out cannot be properly calculated and this may make the rankings inaccurate.

11 PRE-PROGRAMMED LAZER TAG® GAMES

1. CLASSIC LAZER TAG (LTAG)

The object of this game is to be the last player not tagged out. It is an aggressive, go-get-em type of game.

In the Classic LAZER TAG game, all other players are your opponents. [TAG10]

Of all the games you can choose to play, Classic LAZER TAG is the only game that has no hosting or joining at the beginning of the game, no debriefing, ranking, or head-to-head comparisons at the end of the game, and has unlimited time to complete the game. Also, players may enter or leave the game at any time as they wish.

Preset game features are:

- No Hosting, game starts immediately at T-10
- No Teams or Player ID's
- Any number of players may play
- 15 seconds of Shield time allowed
- Unlimited Reloads
- Players are tagged out after taking 10 Tags
- No score ranking – last player NOT tagged out wins
- After being tagged out, the LCD screen will continue to show the game timer running, allowing other players to verify that you did not restart your TAGGER in mid-game. You can use INC and DEC to switch back and forth between this display and a display showing how long you lasted in the game before being tagged out.

2. CUSTOM LAZER TAG (CUST)

The object of this game is to be the last player not tagged out, while scoring as many tags against your opponents as possible.

In the Custom LAZER TAG game, all other players are your opponents. [TAG15]

This variation of Classic LAZER TAG allows all game options to be programmable.

Game features are:

- Fully hosted, (requires hosting/joining) and supports post-game debriefing
- 2-24 players may be in the game, players have individual ID's
- No Teams, All players are opponents of each other
- Time – 1-99 minutes, (default = 10 min)
- Reloads – 0-99 or Unlimited (default = Unlimited)
- Mega-Tags – 0-99 or Unlimited (default = 10)
- Shields – 0-99 seconds (default = 15)
- Tags – 1-99 (default = 10)
- Ranking is individual only
 - Individual ranks are based on receiving 2 points per tag landed on other players, and losing 1 point for every time you're tagged by another player.

3. 2-TEAM CUSTOMIZED LAZER TAG (2TMS) AND

4. 3-TEAM CUSTOMIZED LAZER TAG (3TMS)

The object of these games is to have the most number of your team's players remain in the game, while scoring as many tags as possible on opposing players. [TAG70]

In these games, some of the other players are on the same team as you, while others are on one or two opposing teams.

It is important that you work with your teammates in order to achieve a high team ranking. Do this by helping to protect any of your teammates who are in danger of being tagged out, and working with your teammates to tag the opposing players out as quickly as possible.

Game features are:

- Fully hosted, (requires hosting/joining) and supports post-game debriefing
- 2 or 3 teams of up to 8 players per team
- Team Tags (selectable) – Yes (Y) or No (N) (default =Y)
- Medic Mode (selectable) – Yes (Y) or No (N) (default =Y)
- Time – 1-99 minutes, (default = 15 min)
- Reloads – 0-99 or Unlimited (default = Unlimited)
- Mega-Tags – 0-99 or Unlimited (default = 10)
- Shields – 0-99 seconds (default = 15)
- Tags – 1-99 (default = 20)
- Ranking is individual and team
 - Individual ranks are based on receiving 2 points per tag landed on players from other teams, and losing 1 point for every time you're tagged by a player from another team. Tagging your own teammate (Team Tags) costs you 2 points. Being tagged by your own teammates does not hurt your score.
 - Team ranks are based on which team has the most players not tagged out when the game ends (this gives an advantage to larger teams, so less-skilled players can be grouped together on a larger team to even things out). In the event of a tie, the TAG MASTER will attempt to break the tie based on the individual scores of the players on each team who did not get tagged out

– this rewards the team with the more aggressive players that land more tags. Just hiding or trying to not get tagged may cost your team valuable points that could affect your team's ranking.

5. HUNT THE TAG MASTER (TAGM)

The object of this game is for the TAG MASTER to battle against up to 8 of his most feared opponents! The TAG MASTER is alone on Team 1 while his opponents join forces on Team 2 and go for the hits! [TAG06]

The Host is the TAG MASTER and gets as many tags-until-out and reloads as the entire opposing team gets. For example, if there are 8 players opposing the TAG MASTER, then the TAG MASTER gets as many tags-until-out and tags to launch at his opponents as all 8 of them put together.

Game features are:

- Fully hosted, (requires hosting/joining) and supports post-game debriefing
- 1 team of up to 8 players versus: TAG MASTER who stands alone
- Team Tags (selectable) – Yes (Y) or No (N) (default =Y)
- Medic Mode (selectable) – Yes (Y) or No (N) (default =N)
- Time – 1-99 minutes, (default = 10 min)
- Reloads – 1-10 reloads per opponent (default = 1)
- Mega-Tags – 0-99 or unlimited (default = 0)
- Shields – 0-99 seconds (default = 30)

- Tags – 1-12 tags per opponent (default = 10)
 - Ranking is individual and team
 - Individual ranks are based on receiving 2 points per tag landed on players from the other team, and losing 1 point for every time you're tagged by a player from the other team. Tagging your own teammate (Team Tags) costs you 2 points. Being tagged by your own teammates does not hurt your score.
 - Team ranks are based on whether or not the TAG MASTER makes it to the end of the game without being tagged-out. If he does, then Team 1 (the TAG MASTER) takes first place. If he doesn't, then Team 2 (the opponents) takes first place.
- NOTE: The TAG MASTER will be ranked individually. Therefore, it is possible for the TAG MASTER to make it to the end of the game (enabling his team to win) and also have the lowest individual score (he could have been tagged a lot, but not out). Or, the TAG MASTER may not have made it to the end of the game (meaning his team lost) but could have the highest individual score if he landed a lot of tags, before he was tagged out.

RESPAWN GAMES

In Respawn games, the Host TAGGER becomes the Respawn TAGGER. This is used to create a Respawn Zone which puts players back into the game after they have been temporarily removed from it by taking too many tags. Once a player is tagged 10 times he becomes “Neutralized” and cannot launch

tags, take tags, or raise shields until he is “respawned” back into the game by returning to the Respawn Zone. Players do not receive any additional reloads, shields, Mega-Tags, or tags-until-out when they respawn.

6. RESPAWN (RSPN)

The object of the game is to be the last player standing! Join up to 24 players and don't get tagged out! In this fast paced game, every tenth time a player is tagged, he/she becomes neutralized and must retreat back to the RESPAWN ZONE as fast as possible to be able to get back into the game! [TAG17]

Game features are:

- Fully hosted, (requires hosting/joining) and supports post-game debriefing
- Up to 24 individual players
- No Teams, All players are opponents of each other
- Time – 1-99 minutes, (default = 20 min)
- Reloads – 0-99 or Unlimited (default = 20)
- Mega-Tags – 0-99 or Unlimited (default = 0)
- Shields – 0-99 seconds (default = 30)
- Tags – 1-99 (default = 25)
- Ranking is individual only
 - Individual ranks are based on receiving 2 points per tag landed on other players, and losing 1 point for every time you're tagged by another player.

7. 2-TEAM RESPAWN (2TRS) AND

8. 3-TEAM RESPAWN (3TRS)

The object of these games is to compete against each other to determine who is the best LAZER TAG Team!

Just like the individual RESPAWN game, every tenth time a player is tagged, he/she becomes neutralized and must retreat back to the RESPAWN ZONE as fast as possible to be put back into the game! [TAG 84]

Game features are:

- Fully hosted, (requires hosting/joining) and supports post-game debriefing
- 2 or 3 teams of up to 8 players per team
- Team Tags (selectable) – Yes (Y) or No (N) (default =Y)
- Medic Mode (selectable) – Yes (Y) or No (N) (default =Y)
- Time – 1-99 minutes, (default = 15 min for 2TRS, or 30 minutes for 3TRS)
- Reloads – 0-99 or Unlimited (default = 20)
- Mega-Tags – 0-99 or Unlimited (default = 0)
- Shields – 0-99 seconds (default = 30)
- Tags – 1-99 (default = 25)
- Ranking is individual and team

-Individual ranks are based on receiving 2 points per tag landed on players from other teams, and losing 1 point for every time you're tagged by a player from another team. Tagging your own teammate (Team Tags) costs you 2 points. Being tagged by your own teammates does not hurt your score.

-Team ranks are based on the total combined points of all the members in the team. In the event of a tie, the TAG MASTER TAGGER attempts to break the tie based on which team had the most players not tagged-out when the game ended.

ZONE GAMES

In Zone games the TAG MASTER TAGGER becomes the Zone TAGGER. The Zone TAGGER does not participate in the game as a player although he/she still performs all set-up and programming functions and performs the debriefing at the end of the game.

The Zone TAGGER creates the Zone by generating a 360° infrared light field using its Receiver Dome. The Zone TAGGER should always be stationary during a game and positioned on a

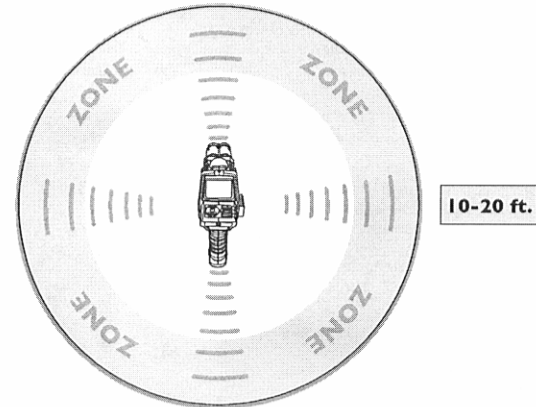

stable surface with the Receiver Dome pointing straight up and level with the ground. The Zone TAGGER should be located in a place so that the Zone can fill a large area, without obstructions that may create dead spots within the Zone.

All TAGGER units in the game sense the Zone using their Receiver Domes. TAGGER units accumulate Zone Time whenever they can sense the Zone. Multiple players may be in the Zone at the same time.

A player may remain in the Zone as long as he/she is not “Neutralized.” When a player takes a Tag from any other player, whether he/she is in the Zone or not, the tagged player becomes “Neutralized” for 15 seconds. The neutralized TAGGER will display “NEUT” with a fifteen-second countdown. A neutralized player cannot tag other players, be tagged by other players, raise shields or add Mega-Tag power. A neutralized player must leave the Zone within 5 seconds of being tagged and remain completely out of the Zone while neutralized. If a player stays in the Zone or returns to the Zone while neutralized, the Zone will become Hostile to that player. A Hostile Zone will cause a player to take multiple tags from the Zone at a pace fast enough to be completely tagged out of the game within just a few seconds.

NOTE: You will still accumulate Zone time if you are in the Zone

with your shields raised. You will NOT accumulate Zone time however, if you are neutralized and are in the Zone.

9. OWN THE ZONE (OWNZ)

The object of the game is to accumulate as much Zone Time as possible.

Own the Zone is a strategic individual game where all players are opponents. Players should focus on getting into and staying in the Zone as long as possible without getting tagged, rather than attacking the opponents. The player with the most Zone Time wins the game. It should be noted that multiple players can be in the Zone at the same time, as long as they can avoid being tagged.

Game features are:

- Fully hosted (requires hosting/joining) and supports post-game debriefing
- 2-24 players
- No Teams. All players are opponents
- Time – 1 - 99 minutes, (default = 10 min)
- Reloads – 0 - 99 or Unlimited (default = 15)
- Mega-Tags – 0 - 99 or Unlimited, (default = 0)
- Shields – 0 - 99 seconds (default = 45)
- Tags – 1 - 99 (default = 10)
- Ranking is individual only
 - Individual ranks are based only on the player’s accumulated Zone Time.

10. 2-TEAMS OWN THE ZONE (2TOZ) AND

11. 3-TEAMS OWN THE ZONE (3TOZ)

The object of the game is to accumulate as much collective Zone Time as possible for the whole team.

These two games are played in the same way as the Individual game of Own the Zone except that the players are divided into teams.

A good team strategy, once a zone is controlled, is to have one player designated as the “Zone Keeper”. This player tries to stay in the zone at all times collecting as much Zone time as possible. The team should also position one or two “defenders” inside the zone and be ready to defend it against incoming hostile players. Finally, two or three “guards” could stay outside the Zone, preventing hostile players from getting close enough to attack the Zone and their teammates inside the Zone. These guards should also attempt to control a safe area so that teammates that are tagged and neutralized (and that must leave the Zone) will have a safe place to go while de-neutralizing. When the Zone Keeper or a defender gets tagged, a guard will need to move into the zone to take his place while the tagged player waits to be un-neutralized. Fluidity, teamwork and coordination are the winning strategies in these games as players on a team move in and out of the Zone, protecting

the Zone, protecting each other and tagging all opponents who attempt to overtake the Zone.

Game features are:

- Fully hosted, (requires hosting/joining) and supports post-game debriefing
- 2 or 3 Teams. Up to 8 players on each team
- Team Tags – Yes (Y) or No (N) (default = N)
- Time – 1 - 99 minutes, (default = 15 min for 2TOZ, and 20 min for 3TOZ)
- Reloads – 0 - 99 or Unlimited (default = 15)
- Mega-Tags – 0 - 99 or Unlimited, (default = 0)
- Shields – 0 - 99 seconds (default = 45)
- Tags – 1 - 99 (default = 10)
- Score ranking is Individual and Team
 - Individual Ranking is based on the total Zone time each individual player accumulates.
 - Team Ranking is based on the total Zone time of all players on a team as a group.

It is recommended that the Team Tags option be left to “N” (No) for team Zone games, as any “ricochets” or reflections inside the Zone (especially when playing indoors) may cause you to accidentally tag everyone on your entire team with a single badly aimed tag forcing them all to leave the Zone. On the other hand, having Team Tags set to “Y” (Yes) makes for a very challenging game!

Build the Ultimate LAZER TAG System!

The Deluxe 1 Player System is also available in green camouflage!

DELUXE 1 PLAYER SYSTEM

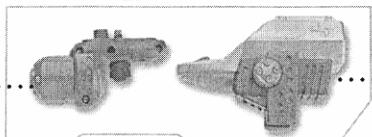

2 PACK ACCESSORY KIT

Accessorize any LAZER TAG TAGGER with the Virtual Scope™ and Thunder Pack™!



IRT-2X TAGGER

IRT-2X TAGGER is also available in green!

2 Pack Accessory Kit shown on Deluxe 1 Player System and IRT-2X TAGGER sold separately.

FCC STATEMENT

This equipment has been tested and found to comply with the limits for a Class B digital device, pursuant to part 15 of the FCC Rules. These limits are designed to provide reasonable protection against harmful interference in a residential installation. This equipment generates, uses and can radiate radio frequency energy, and, if not installed and used in accordance with the instructions, may cause harmful interference to radio communications. However, there is no guarantee that interference will not occur in a particular installation. If this equipment does cause harmful interference to radio or television reception, which can be determined by turning the equipment off and on, the user is encouraged to try to correct the interference by one or more of the following measures:

- Reorient or relocate the receiving antenna.
- Increase the separation between the equipment and the receiver.
- Consult the dealer or an experienced radio/TV technician for help.

Changes or modifications to this unit not expressly approved by the party responsible for compliance could void the user's authority to operate the equipment.

Lazer Tag is a trademark of Shoot the Moon Products and used with permission.

Energizer, Energizer MAX and other marks are trademarks of Eveready Battery Company, Inc.

Product and colors may vary.

®* and/or TM* & © 2004 Hasbro. All Rights Reserved.

® denotes Reg. U.S. Pat. & TM Office.

U.S. Patent No. 5,904,621

71985 P/N 6433100000



TIGER
ELECTRONICS

Where Technology Comes to Play!™*

CHECK OUT ONLINE GAMES AND TIPS AT
www.LAZERTAG.com